

PARTS LIST

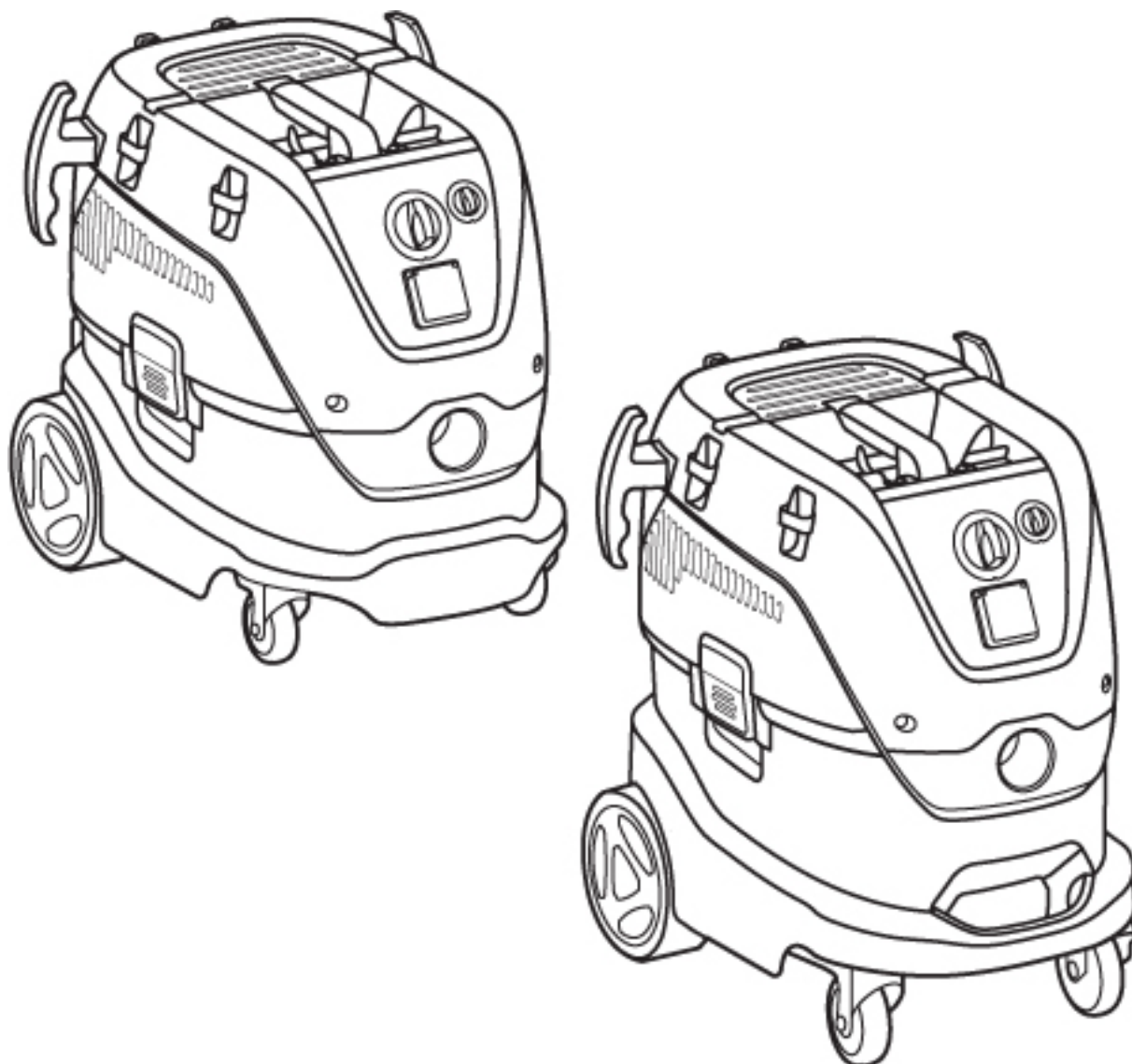

2017.07.31

TABLE OF CONTENTS

Cabinet and control panel 01 IC -21 IC - 2L IC	1
Filter system IC	3
Suction unit L	5
Base_M_L	7
Container 42L	9
Filter and bags	11
Hoses, tubes and nozzles	13
RECOMMENDED SPARE PARTS	15
Accessories 1	17
Airbox	19

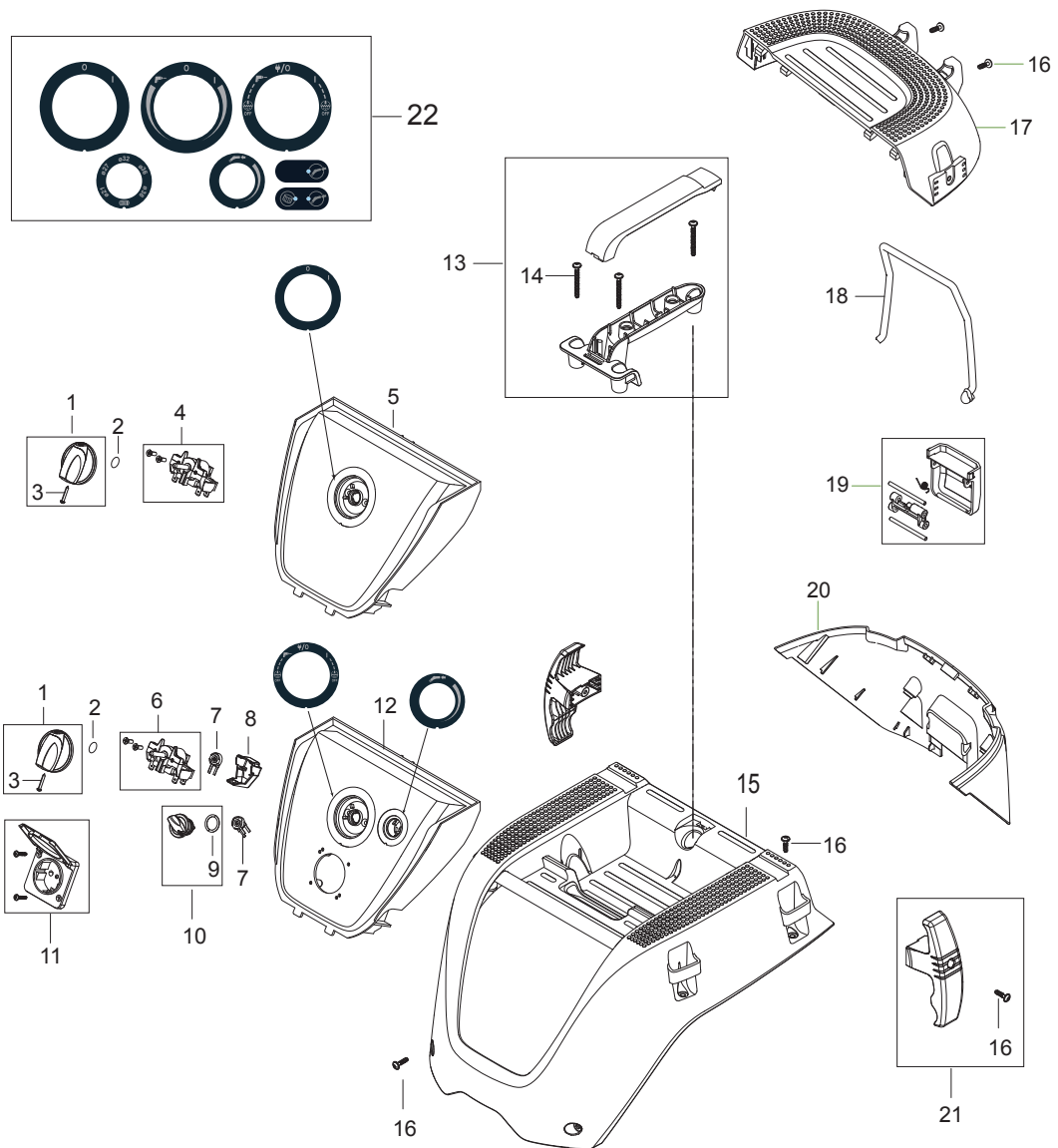

Pos.	Vare-nr	Antal	Beskrivelse	Notes
0	107417576	1	BOX ATTIX 44L NEUTRAL KIT 10 PCS	
0	107417577	1	BOX ATTIX 33L NEUTRAL KIT 10 PCS	
0	107417578	1	BOX ATTIX 44L COLOUR KIT 10 PCS	
0	107417579	1	BOX ATTIX 33L COLOUR KIT 10 PCS	
1	909100204	1	Drejeknap	
2	9868	1	O-ring 10.0X2.5	
3	32526	1	TREAD-CUTTING SCREW 2.9X19 C ISO 1483 ZN	
4	107413448	1	ROTARY SWITCH 2 POS 16A KIT	
5	107415046	1	CONTROL PANEL KIT -01 BLUE	
6	107415085	1	ROTARY SWITCH 5 POS 16A	
7	107415024	2	POTENTIOMETER W. WIRE	
8	107415080	1	CAP FOR POT-METER	
9	3004221	1	O-Ring 16X2	
10	107415062	1	TURNING KNOB D28 BLACK	
11	302004034	1	Stikdåse 16A/250V Eu	
11	302004036	1	SOCKET 16A/250V FR	
11	107400057	1	SOCKET 16A/110V GB	
11	302004336	1	SOCKET 13A/250V GB	
11	302001185	1	SOCKET 10A/250V AU	
11	302004338	1	SOCKET 15A/125V US/CSA	
11	107400059	1	SOCKET 10A/250V CH	
11	107400060	1	Strømuttag 250 V Dk	
12	107415044	1	CONTROL PANEL KIT -21/-2L IC BLUE	
13	107415038	1	HANDLE KIT BLACK	
14	128500203	3	SCREW K50X45 WN1451 SP	
15	107415036	1	TOP COVER BLACK	
16	302004029	17	Screw 5X18	
17	107415086	1	HATCH DOOR UPPER COVER, IC BLACK	
18	107415035	1	CORD STRAP KIT	
19	107418122	1	HATCH DOOR CLAMP 2X SPRING KIT BLACK	[1]
19	107415032	1	HATCH DOOR CLAMP KIT BLACK	[2]
20	107415028	1	HATCHBACK LOWER COVER BLUE	
21	107415083	2	Slange/kabel krog sort 1 stk..	
22	107415077	1	LABEL KIT FOR CONTROL PANEL 7 PCS.	

Part Notes:

- [1] - STOCK COVERS GUARANTEE
For machines produced before November 18th 2016. Serial number 3510164605816
- [2] - For machines produced from November 18th 2016. Serial number 3510164605816

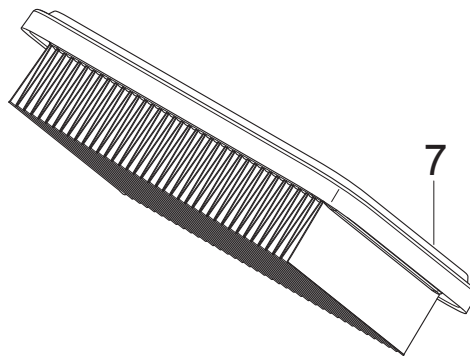
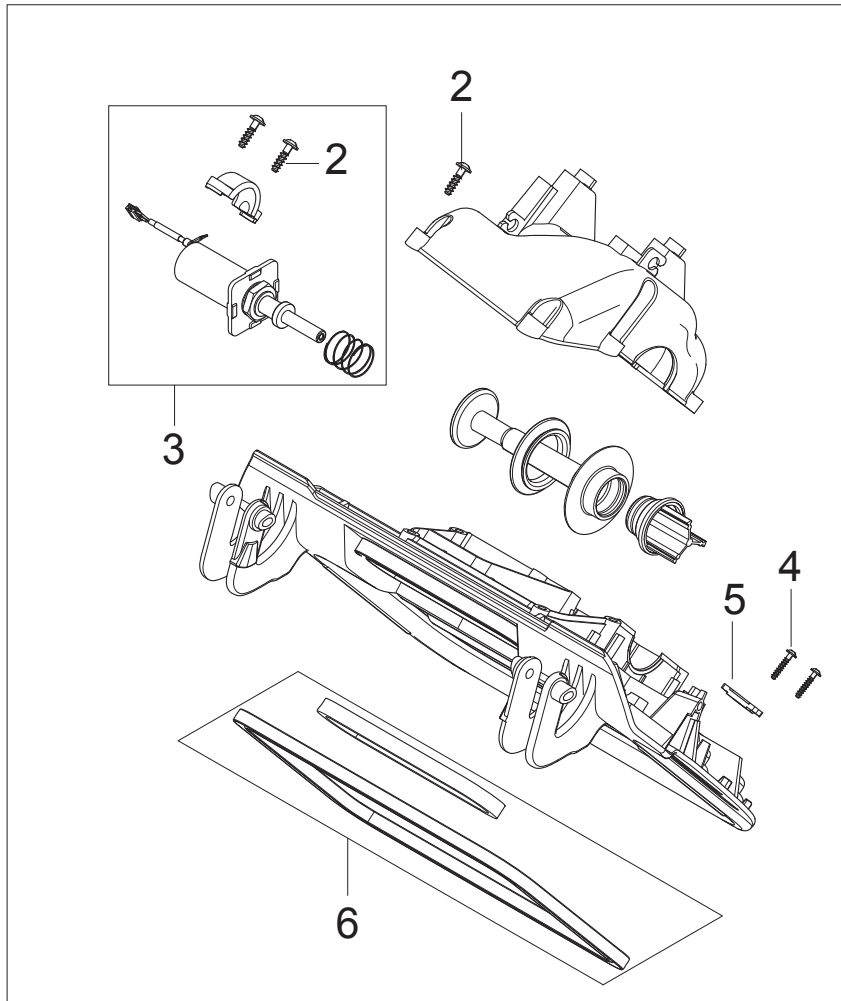

Pos.	Vare-nr	Antal	Beskrivelse	Notes
1	107415027	1	HATCH DOOR FRAME WITH SEALING IC	
1	107417859	1	HATCH DOOR FRAME W. SEALING 100-120V IC	
2	302004029	15	Screw 5X18	
3	107415031	1	SOLENOID KIT 220-240V	
3	107415079	1	SOLENOID KIT 100-120V	
4	302004032	2	SCREW 3.5X18	
5	5697	1	STRAP 3X8X33	
6	107415090	1	HATCH DOOR FILTER GASKET KIT	
7	107413540	1	Hovedfilter PTFE M-klasse 0.5 m2	

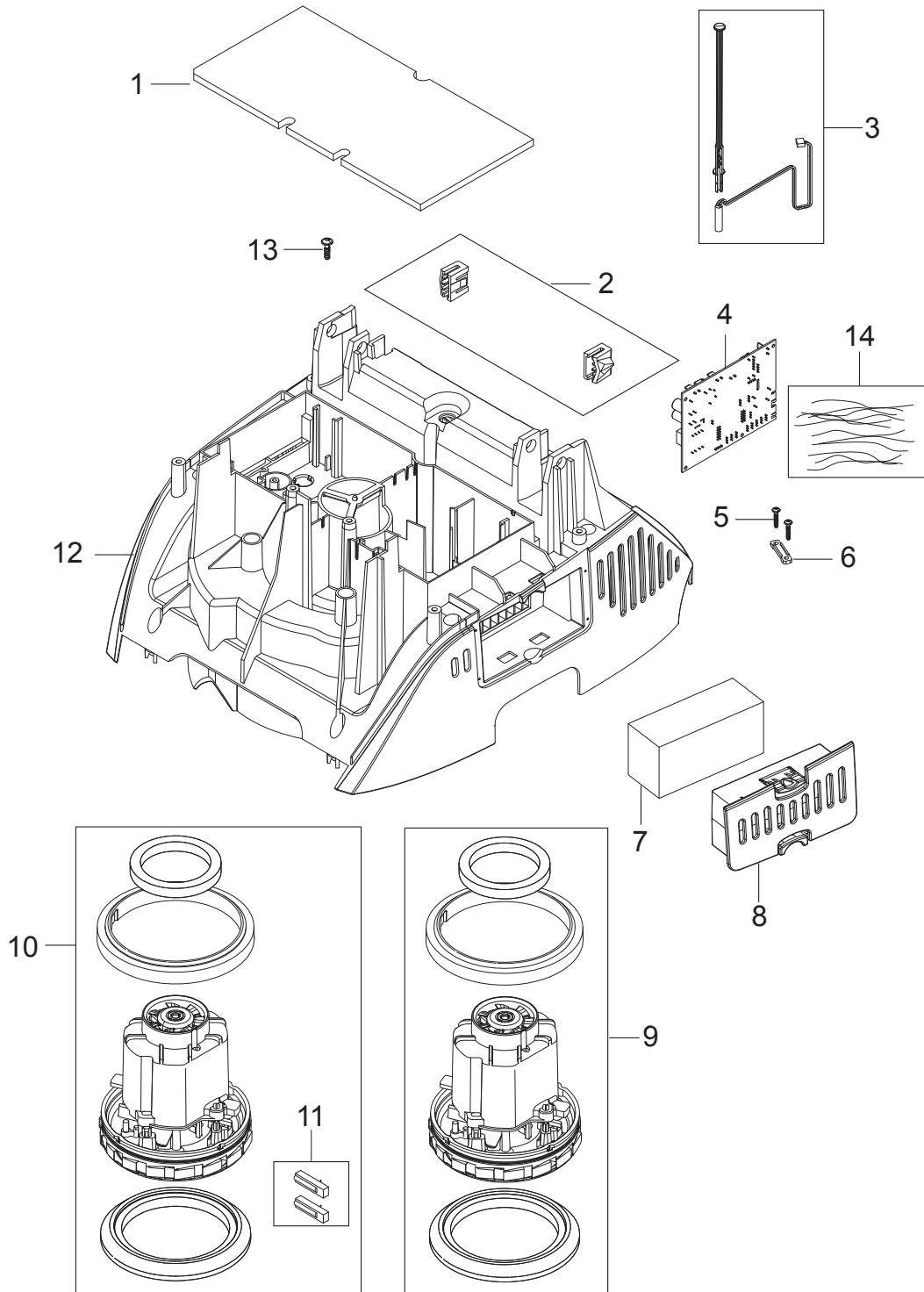

Pos.	Vare-nr	Antal	Beskrivelse	Notes
1	107417101	1	FOAM SEALING 298X148	
2	107415075	1	HATCH DOOR HINGE SNAP 2 PCS.	
3	107415060	1	REED SENSOR WITH APPLICATOR	
4	107415058	1	PCBA AFC 1M1S P2 220-240V	[1]
4	107415649	1	PCBA AFC 1M1S P2 110-120V	[2]
4	107415094	1	PCBA AUTO ON/OFF AFC 1M1S P2 220-240V	[3]
4	107415095	1	PCBA AUTO ON/OFF AFC 1M1S P2 110-120V	[4]
5	302004032	2	SCREW 3.5X18	
6	302004030	1	STRAP FOR CABLE	
7	107415096	1	DIFFUSOR 55X115X45 BLACK	
8	107415097	1	COVER F. MOTORCOOLING FILTER BLUE	
9	107415055	1	MOTOR KIT 1200W 220-240V 50/60HZ	[5]
10	107415099	1	MOTOR KIT 1000W 110-120V 50/60HZ	[6]
11	107417399	1	CARBON BRUSH ASSY KIT 2 PCS 110-120V	[6]
12	107415048	1	AIRGUIDE BLUE	
13	302004029	9	Screw 5X18	
14	107417863	1	WIRE/CAPACITOR KIT6	

Part Notes:

- [1] - 01 IC 220-240V 50/60HZ
- [2] - 01 IC 110-120V 50-60Hz
- [3] - 21 IC 220-240V 50-60Hz
- [4] - 21 IC 110-120V 50-60Hz
- [5] - 220-240V 50/60HZ
- [6] - 110-120V 50/60HZ

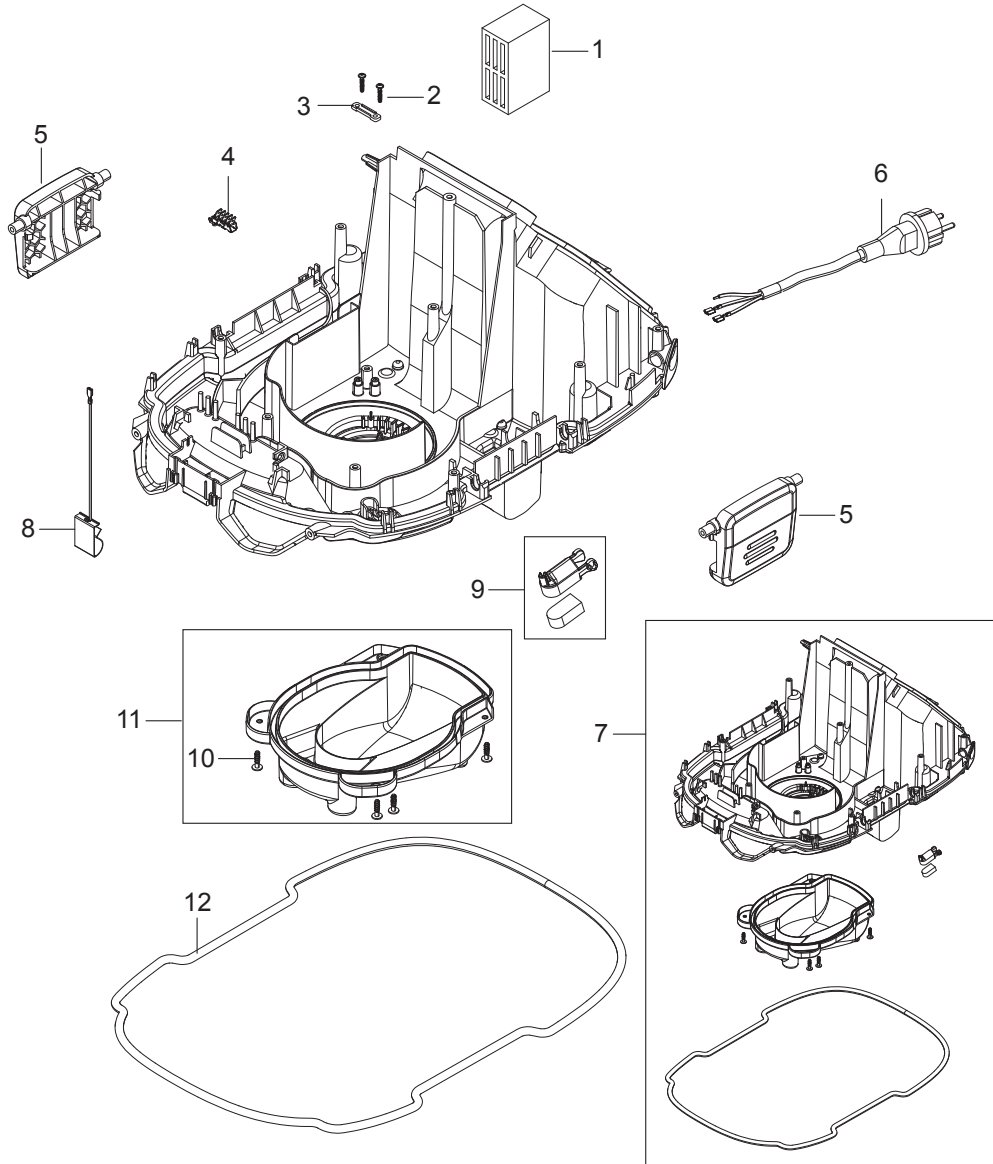

Pos.	Vare-nr	Antal	Beskrivelse	Notes
1	107417112	1	SOUND ABSORBER 83X55X35	
2	302004032	2	SCREW 3.5X18	
3	302004030	1	STRAP FOR CABLE	
4	302004031	1	DISTRIBUTION STRIP 6-POL 16A	
5	107415053	2	CONTAINER CLAMP BLACK	
6	107400573	1	CORD H07RN-F 3G1.5 CEE EU	[1]
6	302001416	1	POWER CORD H07RN-F 3G1.5X8.2	[2]
6	302000692	1	POWER CORD H07BQ-F3G1.5X8.2 CE	[3]
6	302004333	1	POWER CORD H05RR-F 3G1.5X8.4 AS3112 -AU	[4]
6	302000882	1	POWER CORD SJTW-AWG16/3X8	[5]
6	107400267	1	Cord H05Rr-F 3G1.0 Ch	[6]
6	107402642	1	Elkabel, DK	[7]
7	107415074	1	BASE PLATE ASSEMBLY KIT	
8	107417113	1	CONTACT SPRING W. WIRE	
9	107415063	1	FLOATER WITH MAGNET	
10	1814614	4	Skrue K50X18 Wn1451 A2	
11	107415061	1	AIR FLOW COVER KIT BLACK	
12	107415050	1	CONTAINER SEALING	

Part Notes:

- [1] - 220-240V 50/60HZ EU
- [2] - GB 230V
- [3] - 110-120V 50/60HZ GB
- [4] - 220-240V 50/60HZ AU/NZ
- [5] - 120V 50/60HZ US
- [6] - 220-240V 50/60HZ CH
- [7] - 220-240V 50/60HZ DK, grounding

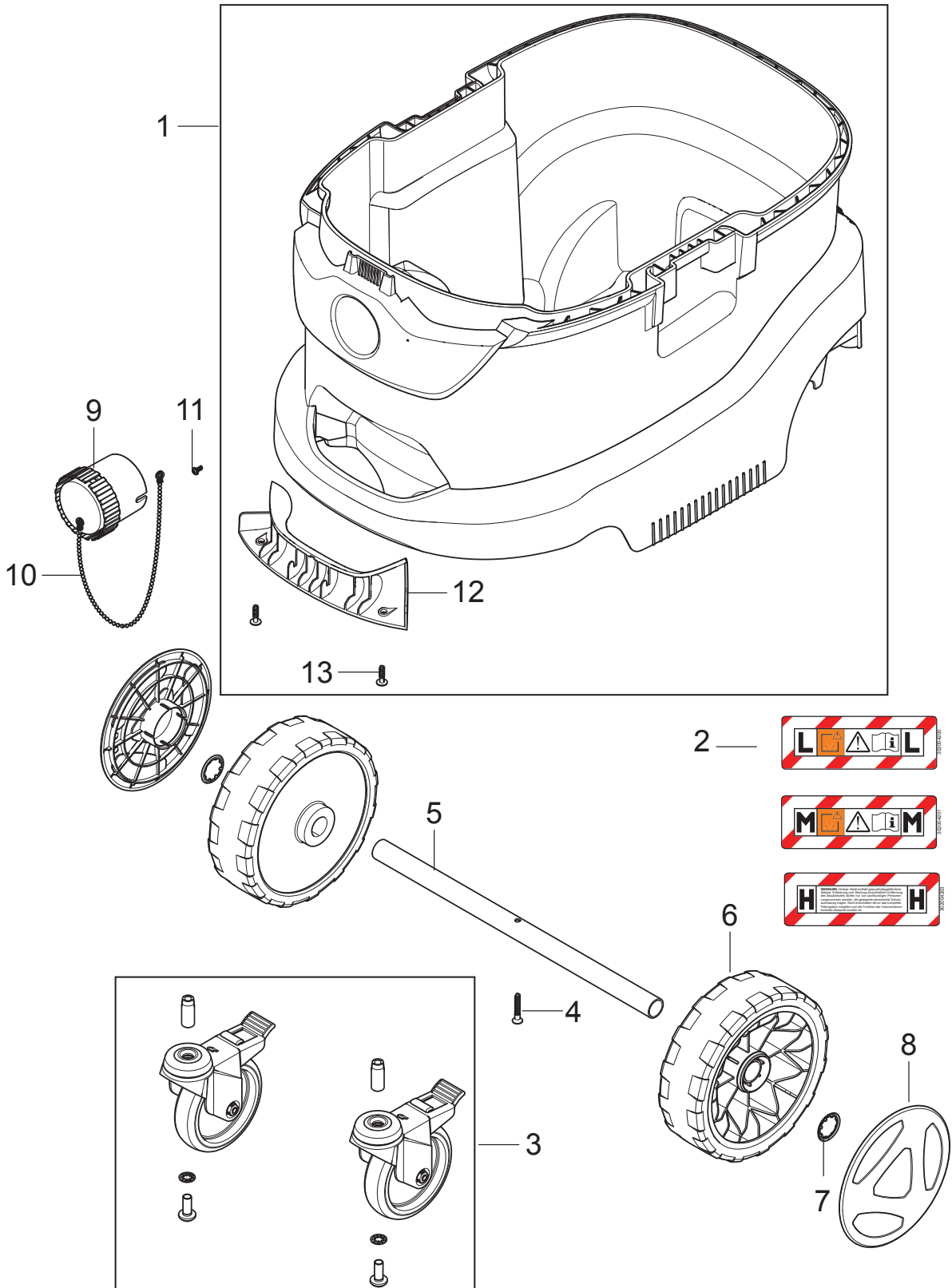

Pos.	Vare-nr	Antal	Beskrivelse	Notes
1	107414073	1	CONTAINER 42L KIT NILFISK BLUE	
1	107417123	1	CONTAINER 42L KIT H-CLASS NILFISK BLUE	
2	107417119	1	LABEL DUSTCLASS L 130X44 PVC	
2	107401291	1	SP-LABEL DUSTCLAS M 130X44 PVC	
2	107401548	1	LABEL DUSTCLASS H 130X44 PVC	
3	107417573	2	CASTOR WHEEL D100 WITH BRAKE 2 PCS	
4	107417864	1	SCREW WN1423 K50X35 BLACK TORX KIT	
5	302004022	1	Hjulaksel	
6	107417121	2	WHEEL D175 BLACK	
7	47302	2	Låseskive	
8	107417122	2	WHEEL CAP D145 BLUE	
9	14775	1	Plastmuffe Ø50	[1]
10	30081	1	BEAD CHAIN 150MM WITH EYES ST/	[1]
11	24738	1	SCREW KA35X 8 WN1411	
12	107417124	1	HANDLE INNER FOR CONTAINER 42L BLACK	
13	302004029	2	Screw 5X18	

Part Notes:

[1] - M and H Class

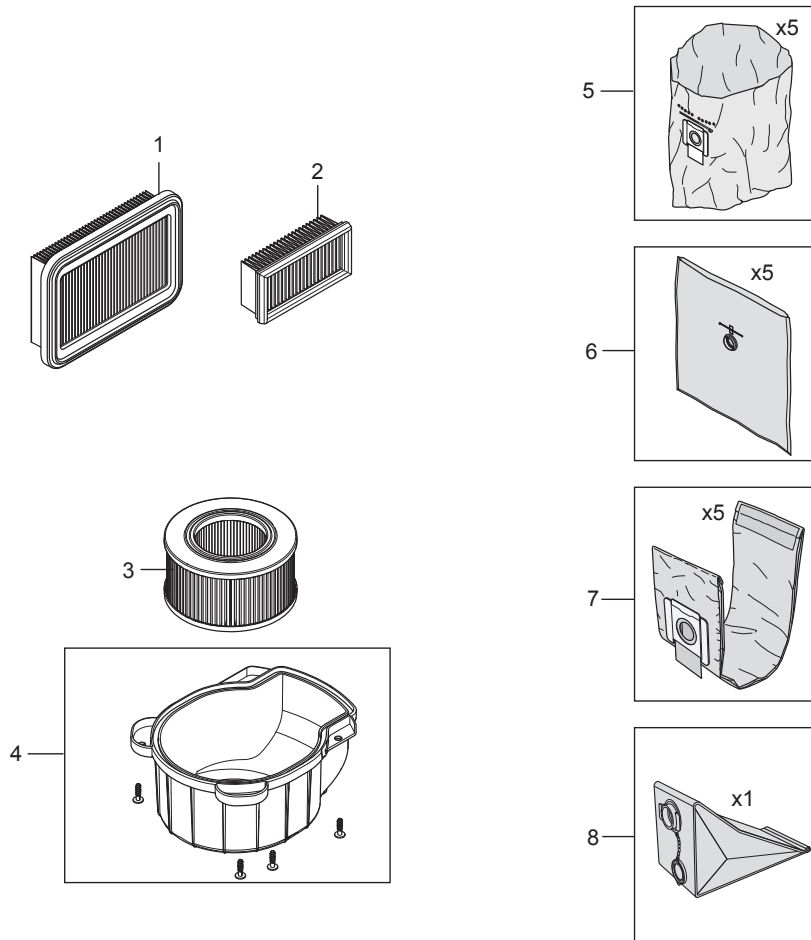

Pos.	Vare-nr	Antal	Beskrivelse	Notes
1	107413540	1	Hovedfilter PTFE M-klasse 0.5 m2	
2	107413541	1	Luffilter til motorkøling PET 1 (stk.)	
3	107413555	1	Filterelement Ø140x75 HEPA H-klasse	
4	107413542	1	Låg til HEPA filter	
5	107417821	1	Affaldsposer sort plast (5 stk.)	
6	107413549	1	Sikkerhedsfilterposer (5 stk.)	
7	107413547	1	Filterposer fleece (5 stk.)	
8	107413556	1	Filterpose Long-life (1 stk.)	

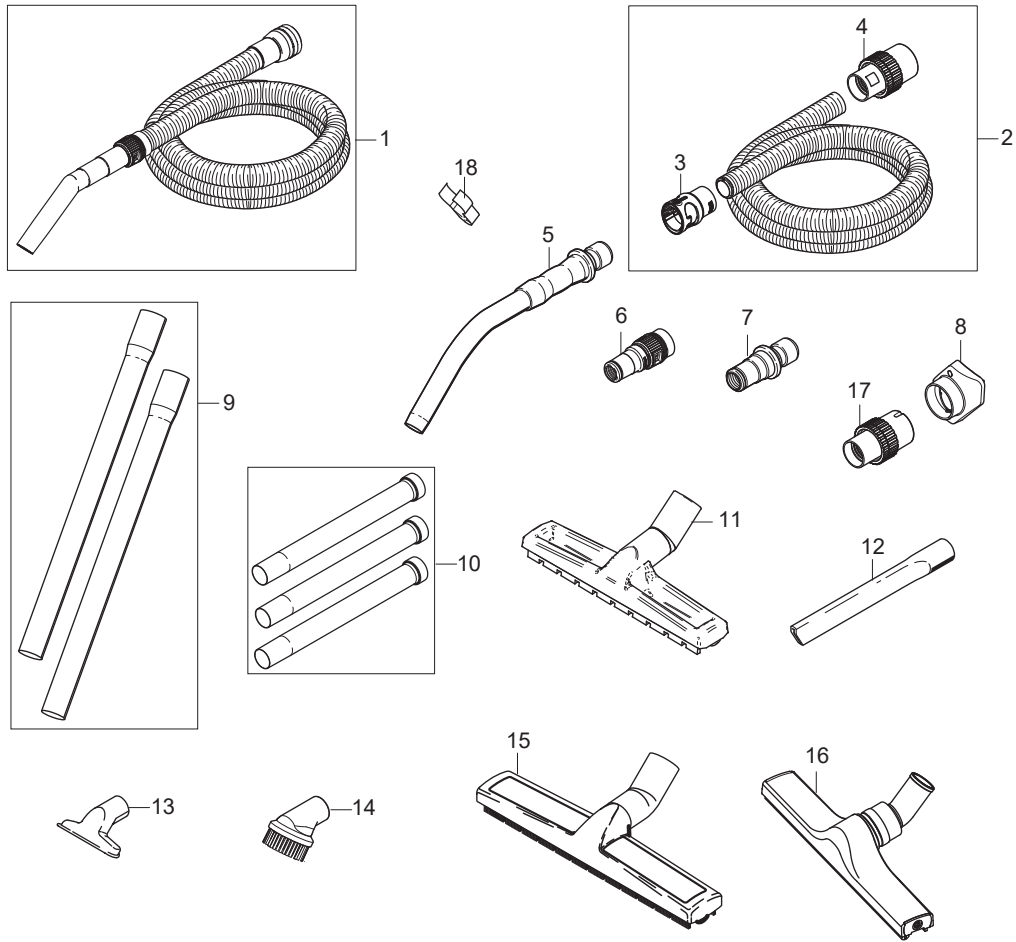

Pos.	Vare-nr	Antal	Beskrivelse	Notes
1	107409976	1	Sugeslange 3,5 m Ø32	[1]
2	107413543	1	Sugeslange AntiStatic rød 4 m Ø32	
2	107413544	1	Sugeslange AntiStatic rød 4 m Ø36	
3	107417868	1	HOSE SLEEVE Ø38 AS QUICKSYSTEM	
3	107417867	1	HOSE SLEEVE Ø36 AS QUICKSYSTEM	
3	107417866	1	HOSE SLEEVE Ø32 AS QUICKSYSTEM	
4	30928	1	Adapt. Antistat Ø32	
4	15812	1	Slangemuffe AntiStatic Ø36	
5	46691	1	Rørbøjning RF stål Ø36	
6	107409977	1	Adapter til værktøj m. regul. Ø27/35/38	[1]
7	302000535	1	Adapter til el-værktøj AntiStatic	
8	107417865	1	Adapter til udblæsningsluft	
9	302000529	1	Forlængerrør krom 500 mm 2 stk. Ø36	
9	107408074	1	Forlængerrør RF 505 mm 2 stk. Ø36	
10	107416995	1	Forlængerrør RF 350 mm 3 stk. Ø36	
11	302002331	1	Gulvmundstykke 300 mm Ø36	
12	29541	1	Fugemundstykke 200 mm Ø36	
13	14295	1	Polstermundstykke plast 115 mm Ø36	
14	302002509	1	Børstemundstykke plast Ø36	
15	60356	1	Gulvmundstykke 360 mm Ø36 wet/dry	
16	302003666	1	Gulvmundstykke 400 mm Ø36	
17	42955	1	Slangemuffe Ø50, ledende type 22	[2]
18	48375	1	Hose Clip	

Part Notes:

- [1] - TSB-LI-VACS-2017-01 - AERO+ATTIX hose
 [2] - To be used with Ø50 mm hose

RECOMMENDED SPARE PARTS

ATTIX 44 IC

2014.11.27

2017.03.24

Pos.	Vare-nr	Antal	Beskrivelse	Notes
1	107413448	1	ROTARY SWITCH 2 POS 16A KIT	
2	107415085	1	ROTARY SWITCH 5 POS 16A	
3	107415076	1	ROTARY SWITCH 3 POS 16A	
4	107415024	1	POTENTIOMETER W. WIRE	
5	107415080	1	CAP FOR POT-METER	
6	302004034	1	Stikdåse 16A/250V Eu	
7	302004036	1	SOCKET 16A/250V FR	
8	107400057	1	SOCKET 16A/110V GB	
9	302004336	1	SOCKET 13A/250V GB	
10	302004338	1	SOCKET 15A/125V US/CSA	
11	107400059	1	SOCKET 10A/250V CH	
12	107400060	1	Strømuttag 250 V Dk	
13	107415038	1	HANDLE KIT BLACK	
14	107415032	1	HATCH DOOR CLAMP KIT BLACK	
15	107415083	1	Slange/kabel krog sort 1 stk..	
16	107415077	1	LABEL KIT FOR CONTROL PANEL 7 PCS.	
17	107415027	1	HATCH DOOR FRAME WITH SEALING IC	
18	107417859	1	HATCH DOOR FRAME W. SEALING 100-120V IC	
19	107415031	1	SOLENOID KIT 220-240V	
20	107415079	1	SOLENOID KIT 100-120V	
21	107415090	1	HATCH DOOR FILTER GASKET KIT	
22	107413540	1	Hovedfilter PTFE M-klasse 0.5 m2	
23	107415075	1	HATCH DOOR HINGE SNAP 2 PCS.	
24	107415058	1	PCBA AFC 1M1S P2 220-240V	
26	107415649	1	PCBA AFC 1M1S P2 110-120V	
27	107415094	1	PCBA AUTO ON/OFF AFC 1M1S P2 220-240V	
28	107415095	1	PCBA AUTO ON/OFF AFC 1M1S P2 110-120V	
29	107415059	1	PCBA AUTO ON/OFF M 1M1S P3 220-240V	
30	107417102	1	PCBA AUTO ON/OFF M 1M1S P3 110-120V	
31	107417103	1	PCBA AUTO ON/OFF AFC M 1M1S P3 220-240V	
32	107417104	1	PCBA AUTO ON/OFF AFC M 1M1S P3 110-120V	
33	107417105	1	PCBA AUTO ON/OFF H 1M1S P3 220-240V	
34	107417106	1	PCBA AUTO ON/OFF AFC H 1M1S P3 220-240V	
36	107416958	1	BUZZER KIT1	
37	107417111	1	PRESSURE SENSOR KIT	
38	107417863	1	WIRE/CAPACITOR KIT6	
39	107415055	1	MOTOR KIT 1200W 220-240V 50/60HZ	
41	107415099	1	MOTOR KIT 1000W 110-120V 50/60HZ	
42	107417399	1	CARBON BRUSH ASSY KIT 2 PCS 110-120V	[1]
43	107415053	1	CONTAINER CLAMP BLACK	
44	107400573	1	CORD H07RN-F 3G1.5 CEE EU	
45	302000692	1	POWER CORD H07BQ-F3G1.5X8.2 CE	
46	302004333	1	POWER CORD H05RR-F 3G1.5X8.4 AS3112 -AU	
47	302000882	1	POWER CORD SJTW-AWG16/3X8	
48	107400267	1	Cord H05Rr-F 3G1.0 Ch	
49	107402642	1	Elkabel, DK	
50	107417418	1	POWER CORD KIT VCTF 1.25MM 3C JP PSE	
51	107415063	1	FLOATER WITH MAGNET	
52	107415061	1	AIR FLOW COVER KIT BLACK	
53	107413542	1	Læg til HEPA filter	
54	107413555	1	Filterelement Ø140x75 HEPA H-klasse	
55	107415050	1	CONTAINER SEALING	
56	107417120	1	CASTOR WHEEL D75 WITH BRAKE 2 PCS.	
57	107417573	1	CASTOR WHEEL D100 WITH BRAKE 2 PCS	
58	107417121	1	WHEEL D175 BLACK	

Part Notes:

[1] - 110-120V 50/60HZ

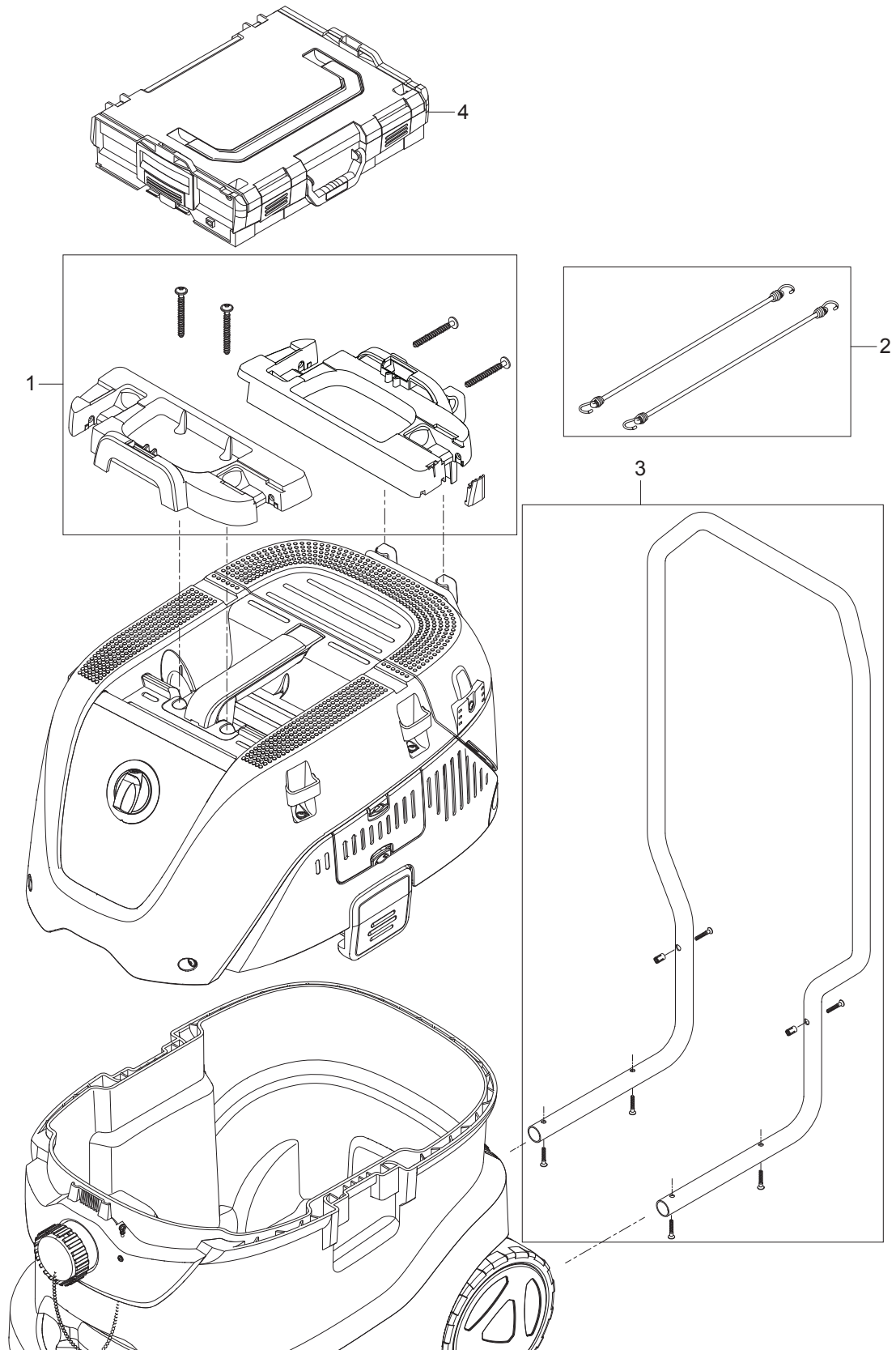

Pos.	Vare-nr	Antal	Beskrivelse	Notes
1	107413551	1	Adapter-plade til værktøjskasse	
2	107413553	1	Bagagestroop (2 stk.)	
3	107413552	1	Kørehåndtag	
4	107413554	1	L-BOXX opbevaringskasse	

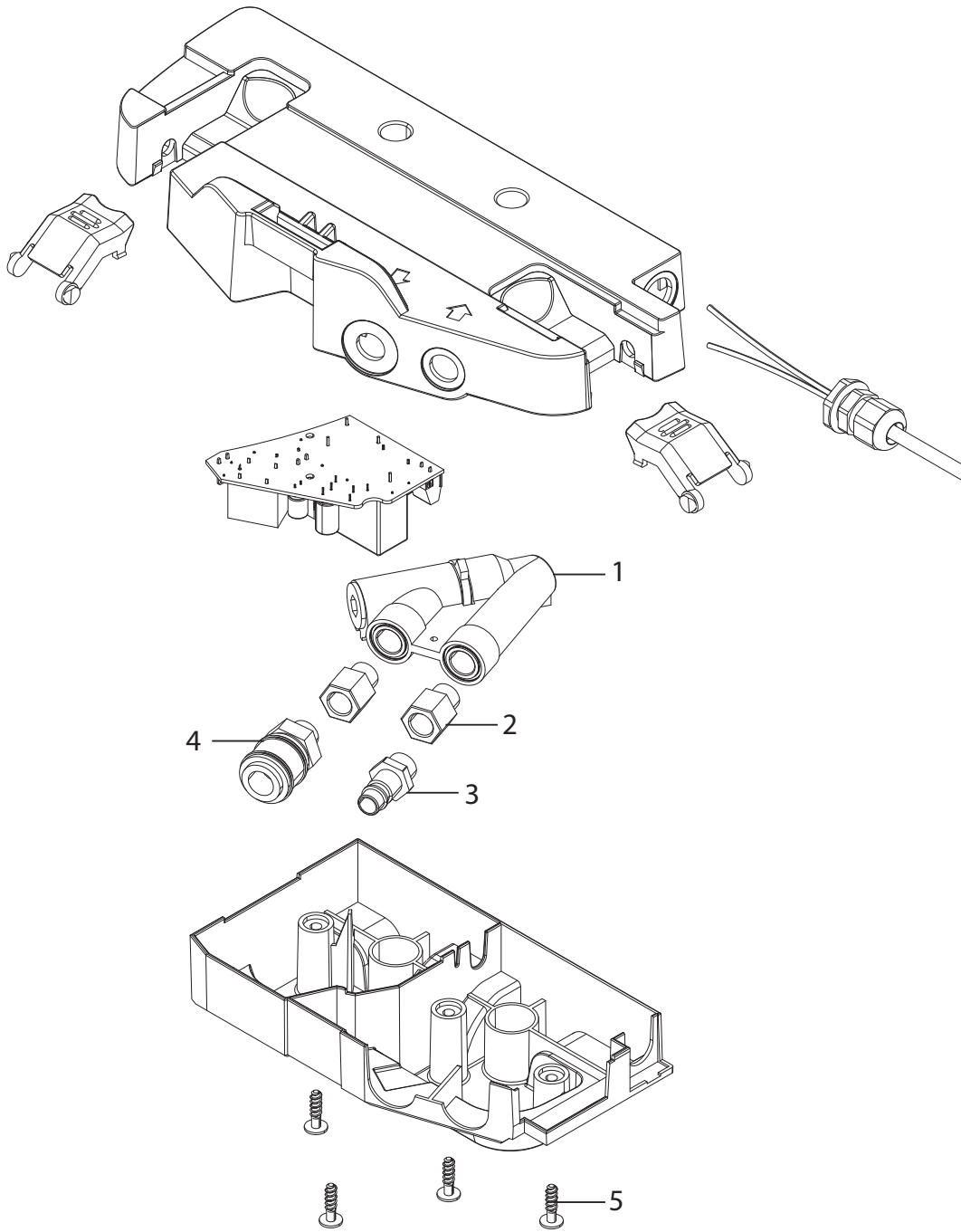

Pos.	Vare-nr	Antal	Beskrivelse	Notes
0	107416370	1	AIRBOX KIT 220-240V 50/60HZ EU	
1	107402622	1	FLOW SENSOR KIT	
2	25437	2	NIPPLE G1/4-R1/4	
3	14809	1	COUPLING MALE G1/4	
4	14808	1	COUPLING FEMALE G1/4	
5	302004029	4	Screw 5X18	

